

PRIX PUBLIC 2023 - Public Price list 2023 (€ HT)

TARIFS SUR MESURE

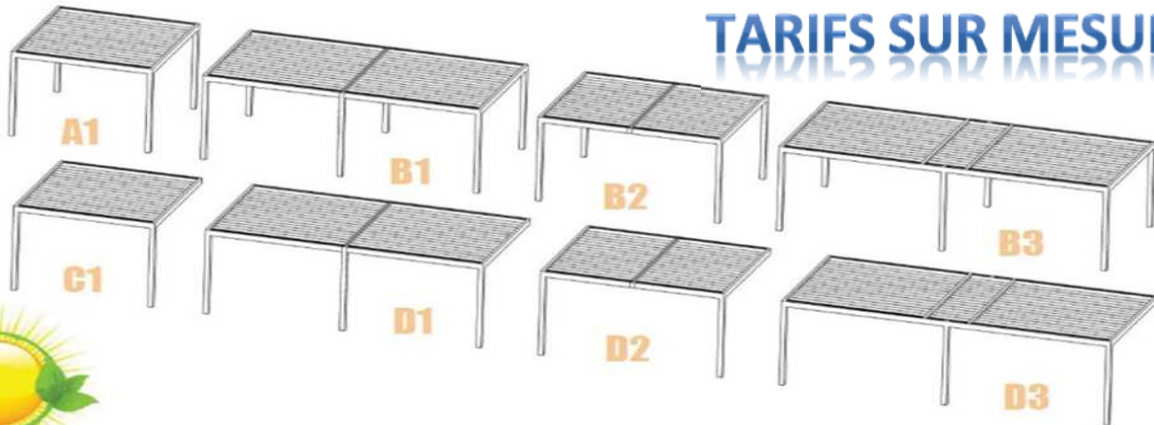

Version autoportée

Largeur Avancée	A1	A1	B2	B2	B1	B1	B3
	2000	3000	4000	4500	5000	6000	7000
1167	1 837 €	1 984 €	2 871 €	2 960 €	3 439 €	3 621 €	4 647 €
1328	1 902 €	2 064 €	2 997 €	3 094 €	3 585 €	3 783 €	4 855 €
1489	1 967 €	2 145 €	3 123 €	3 227 €	3 731 €	3 946 €	5 064 €
1650	2 033 €	2 225 €	3 249 €	3 361 €	3 877 €	4 235 €	5 435 €
1811	2 161 €	2 338 €	3 476 €	3 599 €	4 147 €	4 402 €	5 650 €
1972	2 228 €	2 420 €	3 605 €	3 737 €	4 298 €	4 570 €	5 864 €
2133	2 296 €	2 501 €	3 735 €	3 875 €	4 448 €	4 737 €	6 079 €
2294	2 436 €	2 620 €	3 984 €	4 137 €	4 745 €	5 060 €	6 494 €
2455	2 505 €	2 703 €	4 117 €	4 279 €	4 900 €	5 233 €	6 716 €
2616	2 574 €	2 786 €	4 251 €	4 421 €	5 056 €	5 406 €	6 938 €
2777	2 644 €	2 868 €	4 385 €	4 563 €	5 211 €	5 579 €	7 160 €
2938	2 713 €	2 951 €	4 518 €	4 705 €	5 366 €	5 752 €	7 381 €
3099	2 783 €	3 033 €	4 652 €	4 847 €	5 522 €	5 925 €	7 603 €
3260	2 852 €	3 116 €	4 786 €	4 989 €	5 677 €	6 097 €	7 825 €
3421	2 922 €	3 198 €	4 919 €	5 131 €	5 832 €	6 270 €	8 047 €

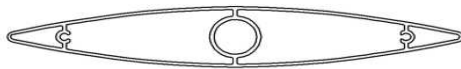
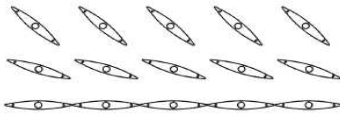

Version adossée

Largeur Avancée	C1	C1	D2	D2	D1	D1	D3
	2000	3000	4000	4500	5000	6000	7000
1167	1 648 €	1 798 €	2 704 €	2 792 €	3 136 €	3 318 €	4 258 €
1328	1 713 €	1 878 €	2 830 €	2 926 €	3 282 €	3 481 €	4 467 €
1489	1 778 €	1 958 €	2 955 €	3 060 €	3 429 €	3 643 €	4 675 €
1650	1 844 €	2 039 €	3 081 €	3 194 €	3 575 €	3 806 €	4 884 €
1811	1 966 €	2 149 €	3 303 €	3 427 €	3 835 €	4 090 €	5 249 €
1972	2 034 €	2 231 €	3 433 €	3 565 €	3 986 €	4 258 €	5 464 €
2133	2 101 €	2 312 €	3 562 €	3 703 €	4 136 €	4 425 €	5 679 €
2294	2 235 €	2 429 €	3 806 €	3 959 €	4 423 €	4 739 €	6 081 €
2455	2 304 €	2 511 €	3 939 €	4 101 €	4 578 €	4 911 €	6 303 €
2616	2 374 €	2 594 €	4 073 €	4 243 €	4 734 €	5 084 €	6 525 €
2777	2 443 €	2 676 €	4 207 €	4 385 €	4 889 €	5 257 €	6 747 €
2938	2 513 €	2 759 €	4 340 €	4 527 €	5 044 €	5 430 €	6 968 €
3099	2 582 €	2 841 €	4 474 €	4 669 €	5 200 €	5 603 €	7 190 €
3260	2 652 €	2 924 €	4 608 €	4 811 €	5 355 €	5 775 €	7 412 €
3421	2 721 €	3 007 €	4 741 €	4 953 €	5 511 €	5 948 €	7 634 €

SPR01 - Protection solaire

Couleurs Standard
Standard colors

Structure:		Gris Anthracite 7016 sablé (grey)
Structure		Gris Galet 7045 sablé (grey)
Toiture:		Gris Anthracite 7016 sablé (grey)
Roof		Blanc 9010 sablé (white)



Personnalisable: 500
Autres couleurs (+15%)

Custom colors (+15%)

FRAIS DE PORT - Transport costs - ----- > Voir conditions (See conditions)

PRIX PUBLIC 2023 - Public Price list 2023 (€ HT)

TARIFS SUR MESURE

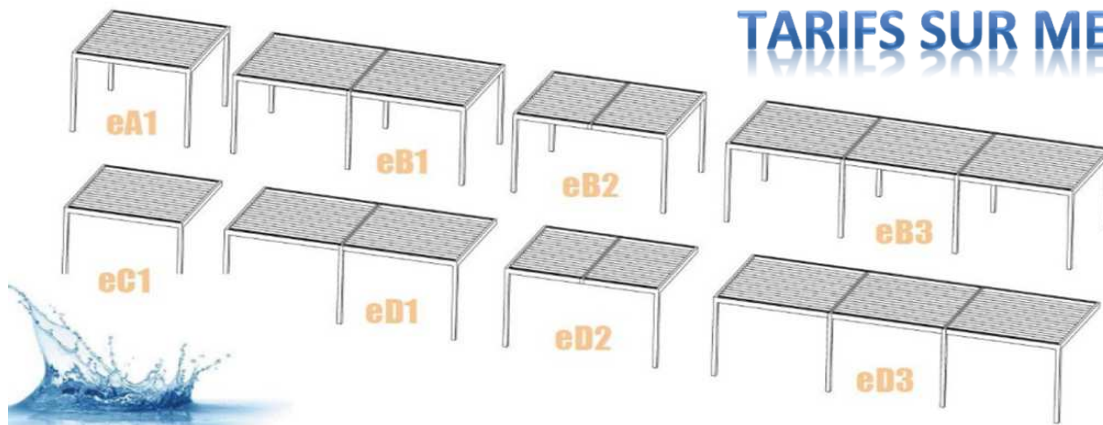

Modèle SPR02.2 (tarif ci-dessous +10%)

SPR02.2 Sans poteau central 1 poteau central

Version autoportée

Largeur Avancée	eA1	eA1	eB2	eB2	eB1	eB1	eB3	eB3
	2000	3000	4000	4500	5000	6000	7000	9000
1183	2 722 €	2 976 €	3 430 €	3 555 €	4 851 €	5 091 €	6 236 €	8 400 €
1344	2 807 €	3 086 €	3 592 €	3 729 €	5 030 €	5 292 €	6 482 €	8 731 €
1505	2 893 €	3 195 €	3 755 €	3 904 €	5 208 €	5 493 €	6 728 €	9 063 €
1666	2 979 €	3 305 €	3 918 €	4 078 €	5 386 €	5 693 €	6 974 €	9 394 €
1827	3 113 €	3 469 €	4 208 €	4 386 €	5 730 €	6 070 €	7 436 €	10 016 €
1988	3 200 €	3 580 €	4 375 €	4 565 €	5 914 €	6 277 €	7 689 €	10 357 €
2149	3 287 €	3 692 €	4 543 €	4 745 €	6 097 €	6 484 €	7 943 €	10 698 €
2310	3 428 €	3 864 €	4 862 €	5 084 €	6 376 €	6 792 €	8 320 €	11 207 €
2471	3 516 €	3 977 €	5 036 €	5 270 €	6 562 €	7 002 €	8 577 €	11 553 €
2632	3 605 €	4 090 €	5 209 €	5 455 €	6 748 €	7 212 €	8 834 €	11 900 €
2793	3 693 €	4 204 €	5 382 €	5 641 €	6 934 €	7 422 €	9 092 €	12 246 €
2954	3 782 €	4 317 €	5 555 €	5 827 €	7 121 €	7 632 €	9 349 €	12 592 €
3115	3 870 €	4 430 €	5 728 €	6 012 €	7 307 €	7 842 €	9 606 €	12 939 €
3276	3 959 €	4 544 €	5 901 €	6 198 €	7 493 €	8 052 €	9 863 €	13 285 €
3437	4 047 €	4 657 €	6 074 €	6 384 €	7 679 €	8 262 €	10 120 €	13 632 €

SPR02.2 jusqu'à 4m -> 7725 € 9292 € 9997€ 12245 € 16495 €

Modèle SPR02.2 (tarif ci-dessous +10%)

SPR02.2 Sans poteau central 1 poteau central

Version adossée

Largeur Avancée	eC1	eC1	eD2	eD2	eD1	eD1	eD3	eD3
	2000	3000	4000	4500	5000	6000	7000	9000
1179	2 499 €	2 594 €	3 211 €	3 336 €	4 537 €	4 776 €	5 851 €	7 881 €
1340	2 585 €	2 697 €	3 373 €	3 510 €	4 715 €	4 977 €	6 097 €	8 212 €
1501	2 670 €	2 800 €	3 536 €	3 685 €	4 893 €	5 178 €	6 343 €	8 544 €
1662	2 756 €	2 904 €	3 698 €	3 859 €	5 071 €	5 379 €	6 589 €	8 875 €
1823	2 886 €	3 097 €	3 981 €	4 159 €	5 406 €	5 746 €	7 039 €	9 481 €
1984	2 974 €	3 204 €	4 149 €	4 339 €	5 590 €	5 953 €	7 292 €	9 822 €
2145	3 061 €	3 310 €	4 317 €	4 519 €	5 773 €	6 160 €	7 546 €	10 164 €
2306	3 249 €	3 417 €	4 629 €	4 851 €	6 140 €	6 463 €	7 917 €	10 664 €
2467	3 339 €	3 524 €	4 802 €	5 036 €	6 329 €	6 673 €	8 174 €	11 010 €
2628	3 429 €	3 630 €	4 975 €	5 222 €	6 518 €	6 883 €	8 432 €	11 357 €
2789	3 519 €	3 737 €	5 148 €	5 408 €	6 707 €	7 093 €	8 689 €	11 703 €
2950	3 609 €	3 843 €	5 321 €	5 593 €	6 896 €	7 303 €	8 946 €	12 050 €
3111	3 699 €	3 950 €	5 494 €	5 779 €	7 085 €	7 513 €	9 203 €	12 396 €
3272	3 789 €	4 056 €	5 667 €	5 965 €	7 274 €	7 723 €	9 460 €	12 742 €
3433	3 879 €	4 163 €	5 840 €	6 150 €	7 464 €	7 933 €	9 717 €	13 089 €

SPR02.2 jusqu'à 4m -> 7441 € 9031 € 9599€ 11758 € 15838 €

Structure:

Structure

Gris Anthracite 7016 sablé (grey)

Toiture:

Roof

Gris Galet 7045 sablé (grey)

Gris Anthracite 7016 sablé (grey)

Blanc 9010 sablé (white)



Personnalisable: 500
Autres couleurs (+15%)

Custom colors (+15%)

FRAIS DE PORT - Transport costs - ----- > Voir conditions (See conditions)

PRIX PUBLIC 2023 - Public Price list 2023 (€ HT)

TARIFS SUR MESURE

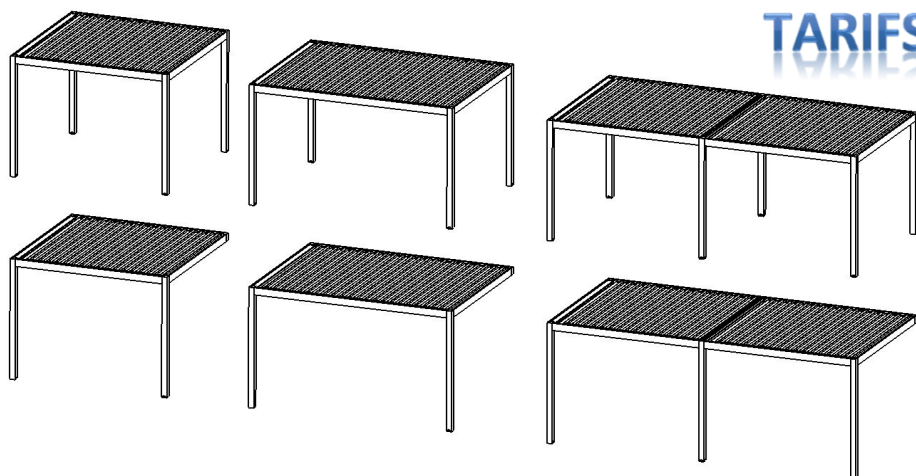

Profondeur maxi: 3m
Largeur maxi 1 module: 3m92
Largeur maxi 2 modules: 7m85

Profondeur au mm (< à 3m)

Rallonge poteau
Réduction poteau

Version autoportée

	Hauteur	Largeur max	Prof.	Réduction largeur	Prix public HT	Prix public TTC	C1
Version inf.3 x inf. 3m	2m50	2m95	< 3m	par pas de 161mm	3 565.83 €	4 279.00 €	267438
Version inf.4 x inf. 3m	2m50	3m92	< 3m	par pas de 161mm	3 932.50 €	4 719.00 €	294938
Version inf.6 x inf. 3m	2m50	5m92	< 3m	par pas de 322mm	6 682.50 €	8 019.00 €	501188
Version inf.8 x inf. 3m	2m50	7m85	< 3m	par pas de 322mm	7 865.00 €	9 438.00 €	589875

Version adossée

	Hauteur	Largeur max	Prof.	Réduction largeur	Prix public HT	Prix public TTC	C1
Version inf.3 x inf. 3m	2m50	2m95	< 3m	par pas de 161mm	3 382.50 €	4 059.00 €	253688
Version inf.4 x inf. 3m	2m50	3m92	< 3m	par pas de 161mm	3 657.50 €	4 389.00 €	274313
Version inf.6 x inf. 3m	2m50	5m92	< 3m	par pas de 322mm	6 407.50 €	7 689.00 €	480563
Version inf.8 x inf. 3m	2m50	7m85	< 3m	par pas de 322mm	7 315.00 €	8 778.00 €	548625

Modification poteaux

Poteau raccourci	< 2m50	57.50 €	69.00 €	4313
Poteau rallongé	> 2m50	99.17 €	119.00 €	7438

Eclairage LED périphérique

Pergola inf. 4x3m	825.00 €	990.00 €	61875
Pergola inf. 6x3m	1 325.00 €	1 590.00 €	99375
Pergola inf. 8x3m	1 650.00 €	1 980.00 €	123750

SPR03 - Protection pluie

Structure:

Structure



Gris Anthracite 7016 sablé (grey)

Toiture:

Roof

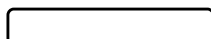

Blanc 9010 sablé (white)



HOME MOTION by **somfy.**

FRAIS DE PORT - Transport costs - ----- > Voir conditions (See conditions)

PRIX PUBLIC 2023- Public Price list 2023 (€ HT)

TARIFS DIMENSIONS STANDARD

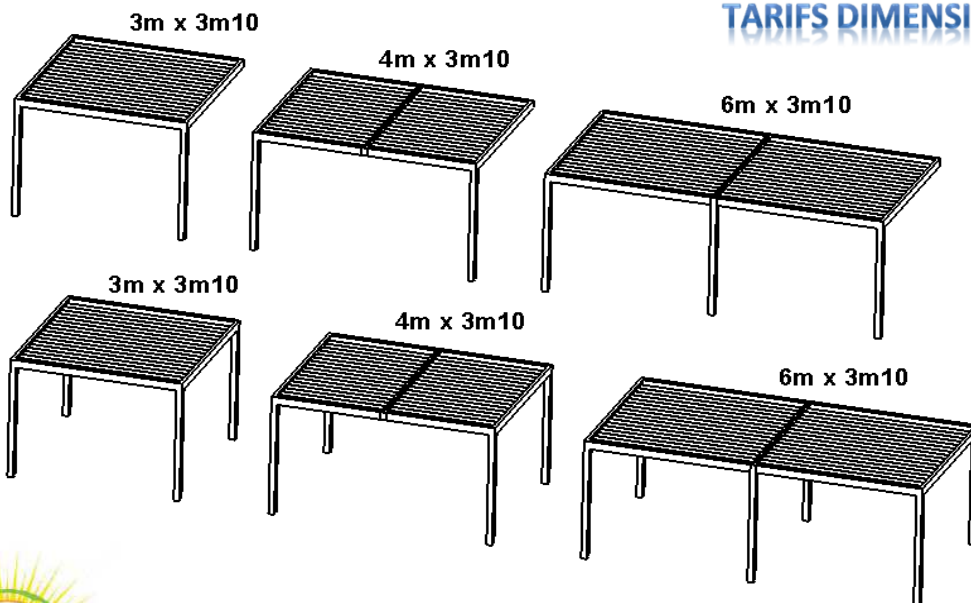

SPR01 - Protection solaire

Poteaux: section 100x100 épaisseur 3mm
 Profil Structure: double section 150x30, épaisseur 2mm
 Lames toitures: section 160x26, épaisseur 2mm, double paroi
 Tringle manoeuvre lame: aluminium, invisible
 Fixation lame: axe inox et bride aluminium

Version autoportée

	Hauteur	Largeur	Profondeur	Prix Public HT	Pric Public TTC	C1
Version 3x3m	2m50	3m	3m10	3 658.33 €	4 390.00 €	263400
Version 4x3m	2m50	4m	3m10	4 408.33 €	5 290.00 €	317400
Version 6x3m	2m50	6m	3m10	5 825.00 €	6 990.00 €	419400

Version adossée

	Hauteur	Largeur	Profondeur	Prix Public HT	Pric Public TTC	C1
Version 3x3m	2m50	3m	3m10	3 325.00 €	3 990.00 €	239400
Version 4x3m	2m50	4m	3m10	4 158.33 €	4 990.00 €	299400
Version 6x3m	2m50	6m	3m10	5 491.67 €	6 590.00 €	395400

Lame toiture 160x26 double paroi
Forte Luminosité et Ventilation



Motorisation incluse avec



HOME MOTION by **somfy.**

Structure:

Structure



Gris Anthracite 7016 sablé (grey)

SPR01 - Protection solaire

Toiture:

Roof



Gris Anthracite 7016 sablé (grey)



FRAIS DE PORT - Transport costs - ----- > Voir conditions (See conditions)

PRIX PUBLIC 2023 - Public Price list 2023 (€ HT)

TARIFS DIMENSIONS STANDARD

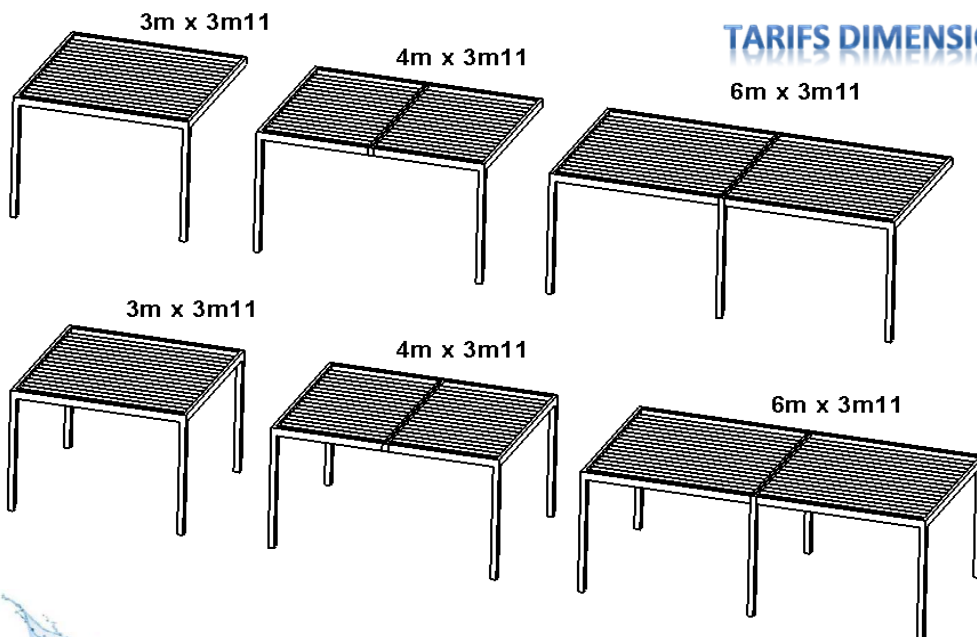

Protection pluie

Poteaux: section 100x100 épaisseur 3mm
 Profil Structure: double section 150x30, épaisseur 2mm
 Lames toitures: section 160x32, épaisseur 2mm, double paroi
 Tringle manoeuvre lame: aluminium
 Fixation lame: axe inox et bride aluminium

Version autoportée

	Hauteur	Largeur	Profondeur	Prix Public HT	Pric Public TTC	C1
Version 3x3m	2m50	3m	3m11	4 408.33 €	5 290.00 €	317400
Version 4x3m	2m50	4m	3m11	5 241.67 €	6 290.00 €	377400
Version 6x3m	2m50	6m	3m11	6 658.33 €	7 990.00 €	479400

Version adossée

	Hauteur	Largeur	Profondeur	Prix Public HT	Pric Public TTC	C1
Version 3x3m	2m50	3m	3m11	4 158.33 €	4 990.00 €	299400
Version 4x3m	2m50	4m	3m11	4 991.67 €	5 990.00 €	359400
Version 6x3m	2m50	6m	3m11	6 408.33 €	7 690.00 €	461400

Lame toiture 160x32 double paroi
Haute résistance avec renfort

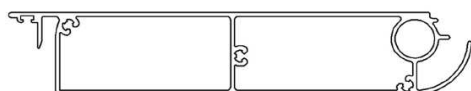

Motorisation incluse avec



LINAK
WE IMPROVE YOUR LIFE

Protection pluie



Structure:	<input type="checkbox"/>	Gris Anthracite 7016 sablé (grey)
Structure	<input type="checkbox"/>	Blanc 9010 sablé (white)
Toiture:	<input type="checkbox"/>	Gris Anthracite 7016 sablé (grey)
Roof	<input type="checkbox"/>	Blanc 9010 sablé (white)

FRAIS DE PORT - Transport costs - ----- > Voir conditions (See conditions)

PRIX PUBLIC 2023 - Public Price list 2023 (€ HT)

TARIFS DIMENSIONS STANDARD

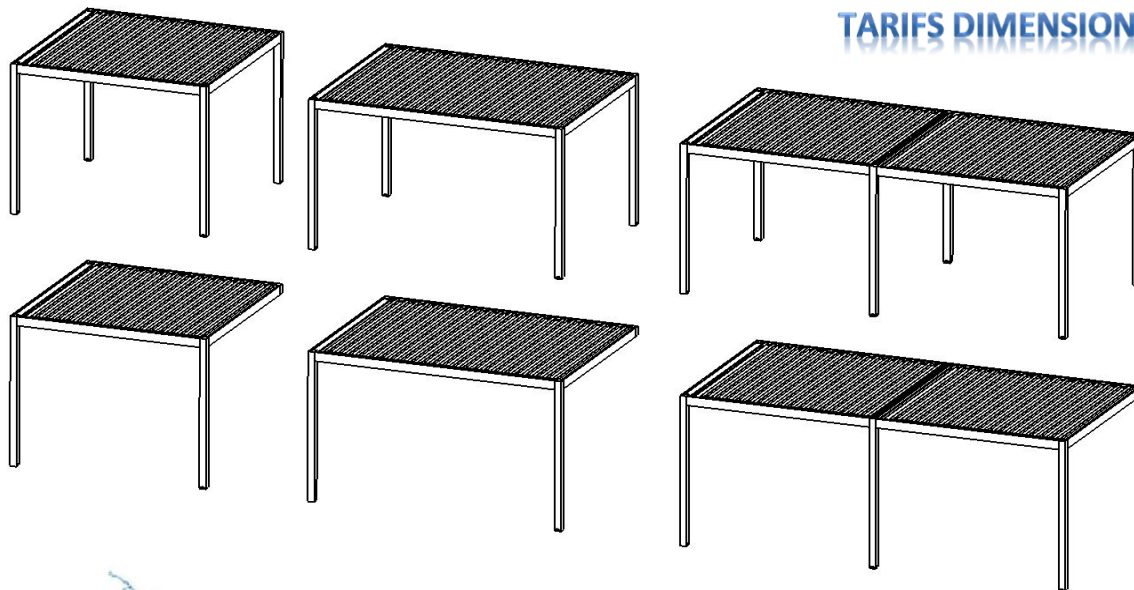

Protection pluie

Poteaux: section 100x100 épaisseur 2 à 3mm
Profil Structure: section 150x99, épaisseur 1,6 à 2mm
Lames toitures: section 175x35, épaisseur 1,6mm
Tringle manoeuvre lame: aluminium
Fixation lame: axe inox et bride aluminium

Version autoportée		Hauteur	Largeur	Profondeur	Prix Public HT	Pric Public TTC	C1
Version 3x3m		2m50	2m95	3m	3 241.67 €	3 890.00 €	243125
Version 4x3m		2m50	3m92	3m	3 575.00 €	4 290.00 €	268125
Version 6x3m		2m50	5m92	3m	6 075.00 €	7 290.00 €	455625
Version adossée		Hauteur	Largeur	Profondeur	Prix Public HT	Pric Public TTC	C1
Version 3x3m		2m50	2m95	3m	3 075.00 €	3 690.00 €	230625
Version 4x3m		2m50	3m92	3m	3 325.00 €	3 990.00 €	249375
Version 6x3m		2m50	5m92	3m	5 825.00 €	6 990.00 €	436875
Store SCREENY 110 ZIP		Hauteur	Largeur	Largeur			C1
Latéral		2m348	2m798		1 658.33 €	1 990.00 €	124375
Avant (4x3m)		2m348	3m722		2 075.00 €	2 490.00 €	155625
Avant (3x3m - 6x3m)		2m348	2m756	2m805	1 658.33 €	1 990.00 €	124375
Eclairage LED périphérique							
Pergola 3x3m - 4x3m					825.00 €	990.00 €	61875
Pergola 6x3m					1 325.00 €	1 590.00 €	99375

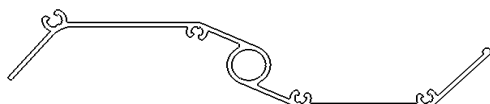

Lame toiture 175x35 simple paroi - Version légère
Motorisation incluse avec télécommande

Structure:
Structure Gris Anthracite 7016 sablé (grey)

Toiture:
Roof Blanc 9010 sablé (white)



HOME MOTION by **somfy.**



FRAIS DE PORT - Transport costs - ----- > Voir conditions (See conditions)

PRIX PUBLIC 2023 - Public Price list 2023 (€ HT)

TARIFS DIMENSIONS STANDARD

Les lames de toiture

SPR01

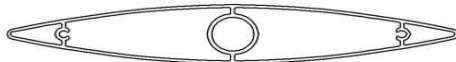

Protection solaire

SPR02

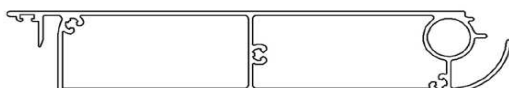

Protection pluie

SPR03

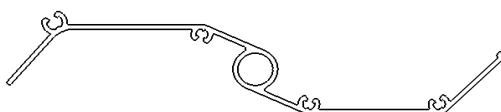

Protection pluie



Version autoportée

Modèle	Protection	Motorisation	Lame toiture	PRIX PUBLIC TTC PERGOLA MOTORISEE		
				3m x 3m	4m x 3m	6m x 3m
SPR01	Solaire	Somfy IO	Ovale 160x26	4 390.00 €	5 290.00 €	6 990.00 €
SPR02	Pluie	Linak	Rectangle 160x32	5 290.00 €	6 290.00 €	7 990.00 €
SPR03	Pluie	Somfy IO	Z 175x35	3 890.00 €	4 290.00 €	7 290.00 €

Version adossée

Modèle	Protection	Motorisation	Lame toiture	PRIX PUBLIC TTC PERGOLA MOTORISEE		
				3m x 3m	4m x 3m	6m x 3m
SPR01	Solaire	Somfy IO	Ovale 160x26	3 990.00 €	4 990.00 €	6 590.00 €
SPR02	Pluie	Linak	Rectangle 160x32	4 990.00 €	5 990.00 €	7 690.00 €
SPR03	Pluie	Somfy IO	Z 175x35	3 690.00 €	3 990.00 €	6 990.00 €



LINAK
 WE IMPROVE YOUR LIFE



HOME MOTION by **somfy**

Structure:	<input type="checkbox"/>	Gris Anthracite 7016 sablé (grey)
Structure	<input checked="" type="checkbox"/>	Blanc 9010 sablé (white)
Toiture:	<input type="checkbox"/>	Blanc 9010 sablé (white)
Roof	<input checked="" type="checkbox"/>	Gris Anthracite 7016 sablé (grey)



FRAIS DE PORT - Transport costs - ----- > Voir conditions (See conditions)

PRIX PUBLIC 2023 - Public Price list 2023 (€ HT)

Façades à lames aluminium (aluminium facades)



*Verrière type
- Atelier -*



*Lames
horizontales
- Fixes -*



*Lames verticales *
- Orientables -*



*Panneaux
- Coulissants -*

Tarif HT Public - Public price HT

<i>Verrière</i>	100 € +	349 € / ml
<i>Lames hor.</i>	100 € +	449 € / ml
<i>Lames vert.</i>	100 € +	599 € / ml
<i>Panneaux coul.</i>	100 € +	599 € / ml

Facturation mini: 1ml

* Largeur: tous les 161mm, une modification de la taille de la pergola pourra être réalisée.

Eclairage LED (Light)



	Module LED de 1m pour SPR01 SPR02 SPR02.2		LED périphérique SPR03	LED périphérique SPR03	
Tarif HT Public - Public price		575.00 €	908.33 €	825.00 €	1 325.00 €
Référence - Reference		2x2m LED 2835	2x3m LED 2835	LED SPR03 3x3 ou 4x3m	LED SPR03 5x3 ou 6x3m
Détails - Details		5000 lumens	7500 lumens	5000 lumens	8000 lumens

Télécommande incluse. (Remote control included)

Panneaux lumineux LED (Lighting panel)

Tarif HT Public - Public price HT

1 241.67 €



Store vertical motorisé (Side blinds)

Largeur \ Hauteur	1000	1200	1600	2000	2400	2800	3200	3600	4000
1200	893	944	1117	1142	1364	1382	1505	1594	1729
1400	913	967	1140	1182	1384	1427	1525	1640	1750
1800	1005	1070	1230	1264	1524	1530	1688	1767	1934
2000	1008	1073	1250	1289	1559	1563	1729	1809	1985
2400	1075	1139	1340	1599	1630	1658	1819	1954	2075

Largeur coffre 110mm - coulisse ZIP - Résistance vent classe 2 - Motorisation et télécommande Somfy IO incluse (motor and remote control included)

Tarif HT Public - Public price HT

Autres finitions (others colors)	forfait = 450€ HT / cde
Autres finitions (others colors)	+15% par store

somfy.



Serge Ferrari



Structure:

Structure



Gris Anthracite 7016 sablé (grey)

Toiture:

Roof



Gris Galet 7045 sablé (grey)



Gris Anthracite 7016 sablé (grey)

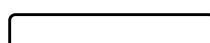

Blanc 9010 sablé (white)



**Personnalisable: 500
Autres couleurs (+15%)**

Custom colors (+15%)

FRAIS DE PORT - Transport costs - ----- > Voir conditions (See conditions)







PRIX PUBLIC 2023 - Public Price list 2023 (€ HT)

Finition (colour) : Blanc (White)

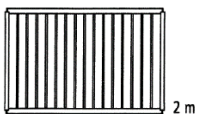
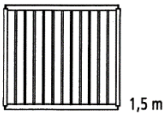
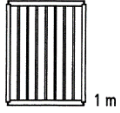
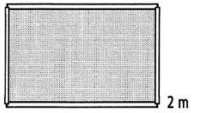
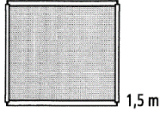
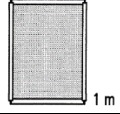
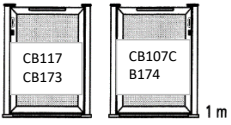
Autres finitions: plus value de 20%. Réalisable à partir de 50ml

Other finishes: price + 20%. Minimum quantity: 50ml

Barreaux (alu. Bars) 137 € / ml
Verre (glass) 170 € / ml

	Référence - Reference	Remplissage - Panel Material	Largeur - Length	Hauteur - Height	Poids - Weight	Nbre de barreaux - Nb. Of vertical bars	Public Prices HT Prix public HT	
Panneaux barreaudage (panels)	 2 m	ALUMINIUM	2m	1,22m	20,7kg	15	199.17 €	
	 1,5 m	ALUMINIUM	1,5m		15,6kg	11	182.50 €	
	 1 m	ALUMINIUM	1m		10,5kg	7	149.17 €	
Panneaux transparents (panels)	 2 m	CV101	VERRE - Glass	1,22m	25kg		265.83 €	
	 1,5 m	CV102	VERRE - Glass		1m01 à 1m50 (sur mesure)	20kg		240.83 €
	 1 m	CV103	VERRE - Glass		1m	15kg		182.50 €
Options	 1 m	CB174	VERRE - Glass	1m	1,22m	32kg	825.00 €	
		CB173	VERRE - Glass	1m		32kg	825.00 €	
	 Poteau d'angle (post)	CB108			1,25m	3,3kg	82.50 €	
 Poteau intermédiaire (post)	CB109			1,25m	2,7kg	74.17 €		
 kit de rigidité pour portillon (kit big trafic for gate)	CB418			1,00m	4,3kg	65.83 €		
 accroche murale (wall fixation)	CB119			1,25m	3,9kg	124.17 €		
 élément de fixation (fixation anckel)	CB112					2.56 €		

FRAIS DE PORT - Transport costs - ----- > Voir conditions (See conditions)

PRIX PUBLIC 2023 - Public Price list 2023 (€ HT)



STANDARD: gris 7016FT, blanc 9010

Standard colors: grey 7016FT, white 9010









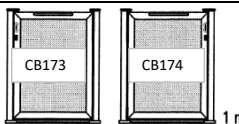

A partir de : 243 € / ml

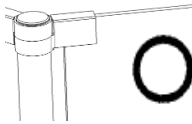

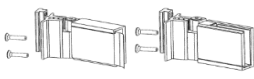
**Personnalisable: 500
autres couleurs**

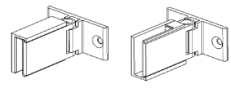
Custom colors

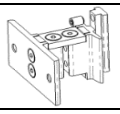
+10 %

			Référence - Reference	Largeur - Length	Hauteur - Height	Poids - Weight	Public Prices HT Prix public HT
Panneaux transparents (panels)	0.48m < ENTRAXE < 1.00m VERRE SECURIT 8MM, CHANTS POLIS	Verre trempé clair (tempered glass 8mm)	SP03-02	1m	1,14m	20kg	124.17 €
	1m01 < ENTRAXE < 1.50m VERRE SECURIT 8MM, CHANTS POLIS	Verre trempé clair (tempered glass 8mm)	SP03-01	1m50		30kg	165.83 €
	1.51m < ENTRAXE < 1.75m VERRE SECURIT 8MM, CHANTS POLIS	Verre trempé clair (tempered glass 8mm)	SP03-03	1m75	35kg	257.50 €	
Portillon	 CB173 CB174	CB173: Tirant droite CB174: tirant gauche	 CB173 / CB174	1m	1,14m	32kg	825 €
Poteau		Avec platine et accessoires (with fixing plate and accesories)	 SP03-04		1,11m	2,7kg	199.17 €
Options		kit de rigidité pour portillon (kit big trafic for gate)	CB418				65.83 €
		Accroche verre sur portillon (glass gate fixation)	 SP03-05				65.83 €
		Accroche murale pour panneau verre (glass wall fixation)	 SP03-08				107.50 €
		Accroche murale pour portillon (gate wall fixation)	 SP03-06				82.50 €
		Elément de fixation (anchor bolt)	CB112				2.56 €

FRAIS DE PORT - Transport costs - ----- > Voir conditions (See conditions)

PRIX PUBLIC 2023 - Public Price list 2023 (€ HT)

SG01 - Section 40x12



SG02 - Section 80x20



SG03 - Section 150x30



SG05 - Losange 40x12



SG06 - Section 100x25

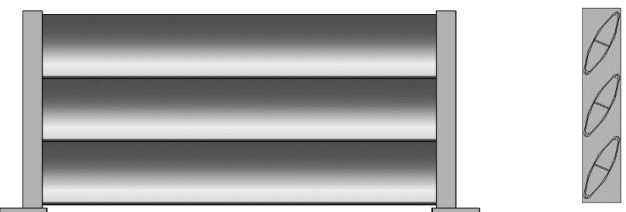

STANDARD: gris 7016FT, blanc 9010

Standard colors: grey 7016FT, white 9010

**Personnalisable: 500
autres couleurs**

Custom colors



**+10 %
+ forfait 265€ HT**

Hauteur - Height	Tarif HT Public - Public price HT
< 40cm	82.50 € / ml
40 -> 59cm	124.17 € / ml
60 -> 79cm	157.50 € / ml
80 -> 99cm	199.17 € / ml
100 -> 119cm	232.50 € / ml
120 -> 139cm	265.83 € / ml
140 -> 159cm	299.17 € / ml
160 -> 179cm	340.83 € / ml
180 -> 199cm	407.50 € / ml
200 -> 235cm	474.17 € / ml
235 -> 250cm	499.17 € / ml

Tarif au mètre linéaire incluant:

- la réalisation sur mesure des panneaux
- les poteaux pour clôture rectilignes et angles à 90°
- la couleur au choix
- le pré-montage des panneaux
- les accessoires (platinas de fixation, caches, visserie)
- les frais de dossier et frais d'études
- le conditionnement

Mètre linéaire projet = somme de l'ensemble des longueurs de clôture équipées de panneaux aluminium (y compris portillon)

Price list includes:

- The custom-made realization of panels
- posts for fence rectilinear and angles in 90 °
- the color in the choice
- the pre-assembly of panels
- accessories (platinums of fixation, finish parts, bolts,...)
- Studding costs
- the packaging

Linear meter project = sum of the set of the lengthes of fence equipped with

Options - Options	Tarif (price) HT
Portillon (Gate)	575 €
Poteau angle spécial (Specific angle)	42.50 €
Poteau avec dénivelé (Offset Post)	42.50 €
Découpe spécifique (specific cutting)	165.83 €
Personnalisation panneau (customized panel)	Tarif / ml + 15%

Personnalisation du panneau:

- les entraxes standards de lames peuvent être modifiés selon votre choix (plus ou moins d'écartement, lames jointives,...)
- plusieurs types de lames peuvent être associés sur un même panneau. Code tarif = code tarif le plus élevé des lames du panneau

Customized panels:

- The standard blade distance center-to-center and the spacing can be modified according to your choice (more or less of space, no spacing)
- several types of blades can be associated on the same panel. Price Code = the most expensive price of the different blades chosen.

PRIX PUBLIC 2023 - Public Prices 2023 (€ HT)

Finition: Standard gris anthracite 7016 sablé

Personnalisable: 500 couleurs au choix

*Finish: Frosted anthracite grey colouring (RAL 7016)
Other finishes made to measure (+15%)*

+15 %



<i>REFERENCE - Reference</i>	<i>Commande - Control</i>	<i>Sécurité NFEN 1111 - Safety device</i>	<i>Option rince pied - Foot Bath</i>	<i>Modèle Mitigeur - Control fitting model</i>	<i>Public Prices HT Prix public HT</i>
KELIA SW01-PR	Temporisée - <i>timed</i>	OUI - <i>Yes</i>	OUI - <i>Yes</i>	PRESTO	2 491.67 €
KELIA SW01-DL	Temporisée - <i>timed</i>	OUI - <i>Yes</i>	OUI - <i>Yes</i>	DELABIE	2 491.67 €
KELIA SW02-PR	Temporisée - <i>timed</i>	OUI - <i>Yes</i>	NON - <i>No</i>	PRESTO	2 325.00 €
KELIA SW02-DL	Temporisée - <i>timed</i>	OUI - <i>Yes</i>	NON - <i>No</i>	DELABIE	2 325.00 €
KELIA SW03-PR	Temporisée - <i>timed</i>	NON - <i>No</i>	OUI - <i>Yes</i>	PRESTO	2 325.00 €
KELIA SW03-DL	Temporisée - <i>timed</i>	NON - <i>No</i>	OUI - <i>Yes</i>	DELABIE	2 325.00 €
KELIA SW04-PR	Temporisée - <i>timed</i>	NON - <i>No</i>	NON - <i>No</i>	PRESTO	2 075.00 €
KELIA SW04-DL	Temporisée - <i>timed</i>	NON - <i>No</i>	NON - <i>No</i>	DELABIE	2 075.00 €
KELIA SW05	Manuelle - <i>manual</i>	OUI - <i>Yes</i>	OUI - <i>Yes</i>	ROCA	2 325.00 €
KELIA SW06	Manuelle - <i>manual</i>	OUI - <i>Yes</i>	NON - <i>No</i>	ROCA	2 075.00 €
KELIA SW07	Manuelle - <i>manual</i>	NON - <i>No</i>	OUI - <i>Yes</i>	ROCA	2 075.00 €
KELIA SW08	Manuelle - <i>manual</i>	NON - <i>No</i>	NON - <i>No</i>	ROCA	1 908.33 €
FRAIS DE PORT - Transport costs - ----- > Voir conditions (See conditions)					